

# VERY



## Shingle roomdivider

Inspired by traditional roofs made out of wooden shingles, this intriguing roomdivider provides you with visual privacy and acoustic dampening.

The geometric shingles can easily be re-arranged in overlapping or spaced settings. And they can also be combined into curved walls, forming a snakeskin like texture.

### Material

Recycled PET felt shingles, steel frame.

### Packaging quantity

Sold in pairs (one high and one low shingle).

### Designer

Sander Mulder



### Felt colors

23 colors available, see next page.

### Frame color

white, micro structure powder coating.

black, micro structure powder coating.

any RAL color available upon request.

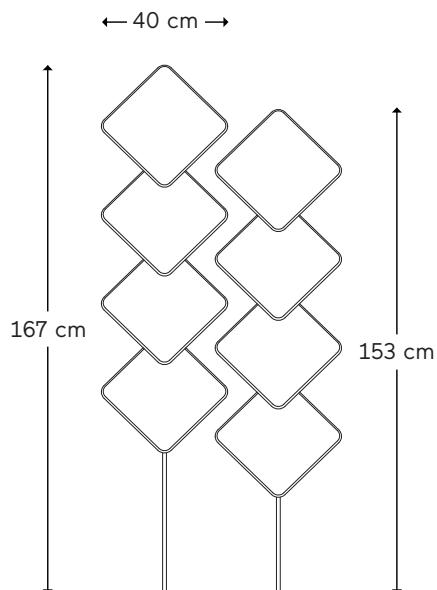

# VERY



## PET felt

### Characteristics

A minimum of 50% of our felt is composed of recycled PET beverage bottles.

Thickness: 9 mm

Density: 1.9 kg/m<sup>2</sup>

### Application

Thanks to the large variety of colors we can offer, the felt panels can be used in any environment from office spaces and hotels to public buildings and classrooms.



## Colors

Slight color deviations may occur since PET Felt panels are made from recycled fibers.



Recycled & recyclable



Sound absorption



Fire retardant  
Bs1- 0d0



Made from  
PET bottles



BZ-07



BZ-05



BZ-43

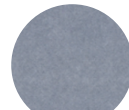

BZ-47

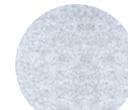

BZ-11

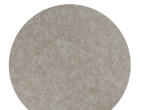

BZ-12



BZ-04



BZ-46

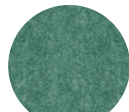

BZ-10



BZ-25

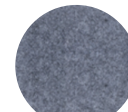

BZ-36

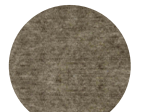

BZ-31



BZ-33



BZ-08



BZ-17

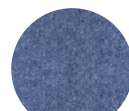

BZ-09

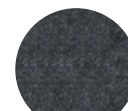

BZ-03



BZ-39



BZ-35



BZ-48

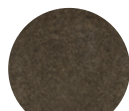

BZ-34

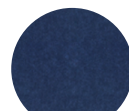

BZ-19



BZ-13